

New surge protective devices

SUITABLE SOLUTIONS
FOR ALL TYPES OF INSTALLATIONS
AND ALL RISK LEVELS

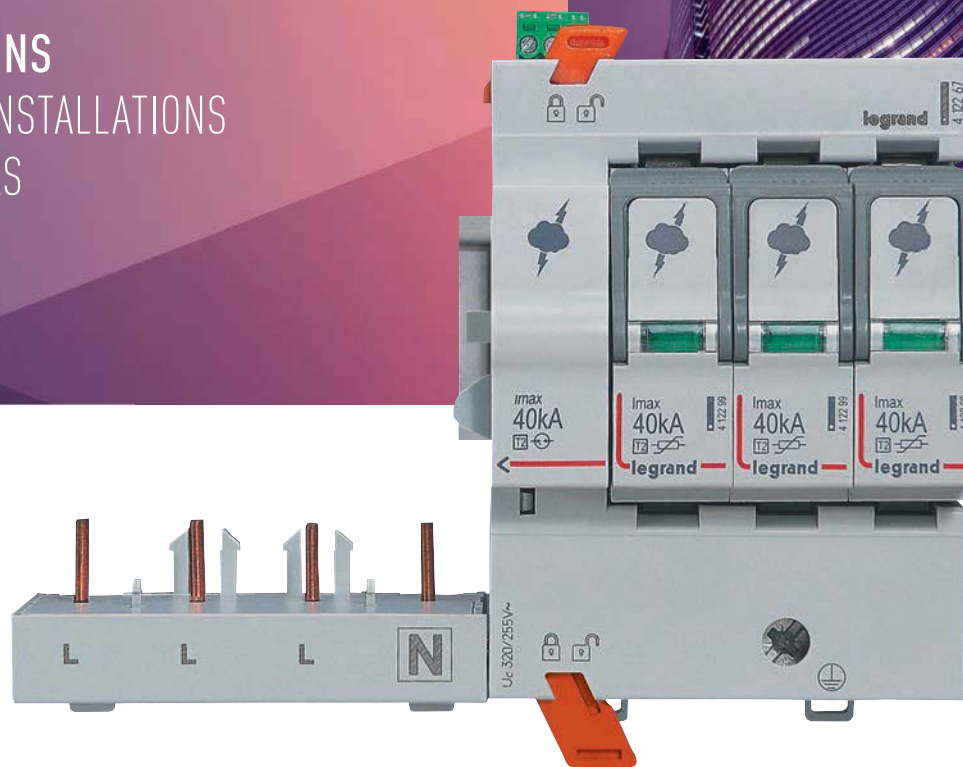

CATALOGUE
PAGES
INSIDE
→

THE GLOBAL SPECIALIST
IN ELECTRICAL AND DIGITAL BUILDING INFRASTRUCTURES

 **legrand**[®]

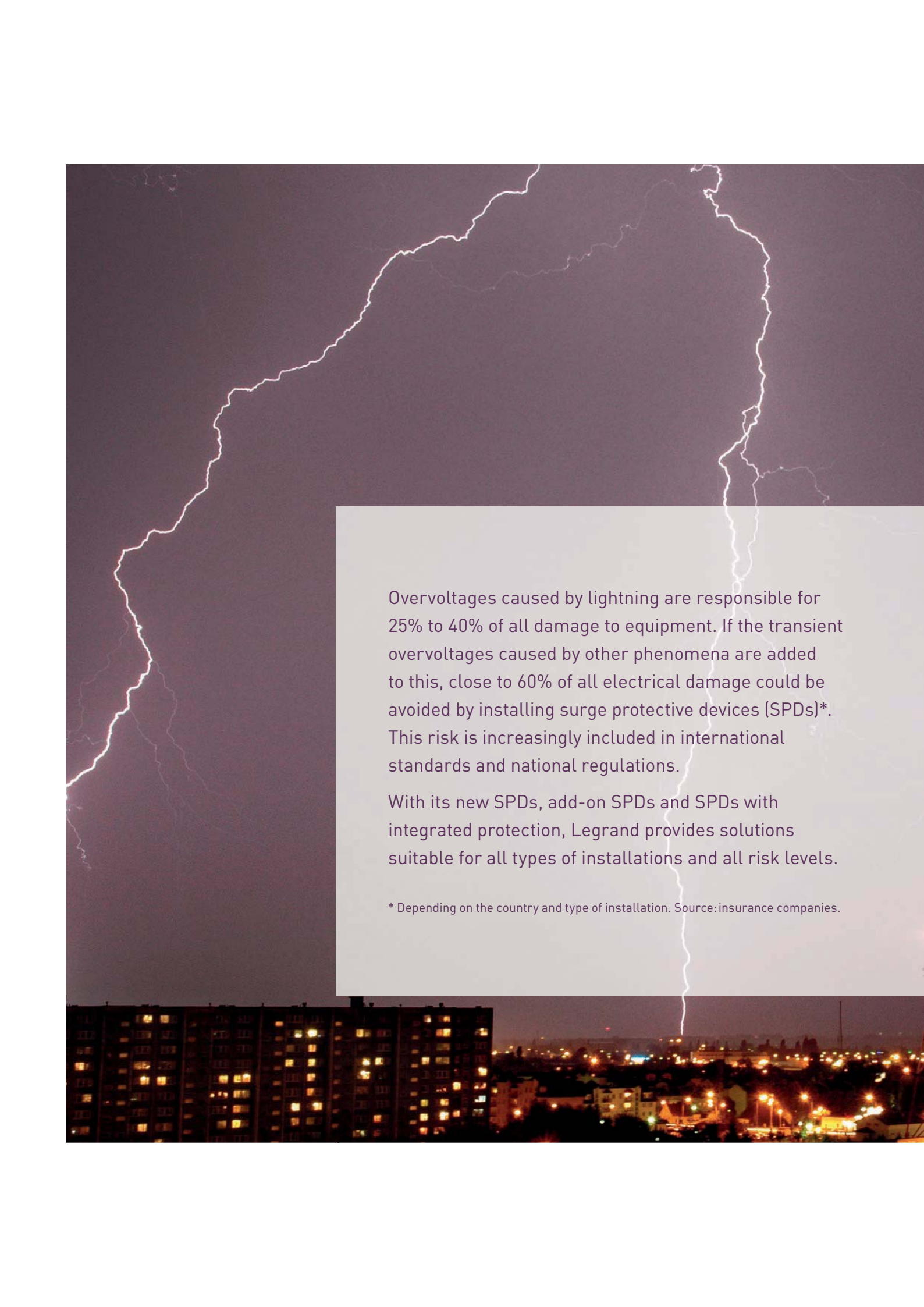

Overvoltages caused by lightning are responsible for 25% to 40% of all damage to equipment. If the transient overvoltages caused by other phenomena are added to this, close to 60% of all electrical damage could be avoided by installing surge protective devices (SPDs)*. This risk is increasingly included in international standards and national regulations.

With its new SPDs, add-on SPDs and SPDs with integrated protection, Legrand provides solutions suitable for all types of installations and all risk levels.

* Depending on the country and type of installation. Source: insurance companies.



New Surge Protective Devices (SPDs)

- 2 **New Legrand SPDs**, a complete range for all risk levels
- 4 **Optimum protection** and adaptability to suit local habits
- 6 **Add-on SPDs**, increased reliability and safety
- 8 **Design and functionality**, perfect integration in distribution boards

New SPDs, a complete range for all risk levels

For protection against transient overvoltages to be effective, the position of the SPD in the installation and the type of SPD must be appropriate for the level of risk. Conforming fully to international standards, Legrand's range of type 1 (T1) and 2 (T2) SPDs meet all the requirements of low voltage installations.



SPDs WITHOUT INTEGRATED PROTECTION (T1, T1+T2 AND T2)

These SPDs require associated protection by means of a circuit breaker or fuse. They are designed to protect commercial and industrial installations.

ADD-ON SPDs (T2)

The protective circuit breaker is connected directly to the SPD with no wiring (see page 13). These SPDs are designed to protect commercial and industrial installations in their secondary distribution boards.

STANDARDS EN 61643-11
AND IEC 61643-11

The entire range of Legrand SPDs conforms to standards EN and IEC 61643-11. The standards distinguish two types of SPD for distribution boards: T1 and T2.

T1 SPDs are designed to provide protection in the main distribution boards and T2 SPDs mostly provide protection in secondary distribution boards or consumer units. T1+T2 SPDs, which are increasingly used at the supply end of installations, comply with the specifications of both types.

CASCADED PROTECTION

The only way to discharge all the initial energy is to install SPDs at every level of the installation.

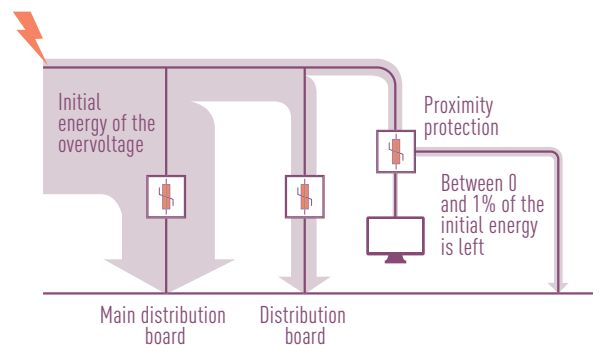

SPDs WITH INTEGRATED
PROTECTION (T2)

Protection against overloads and short-circuits is incorporated in the SPD. This is the most straightforward choice for small commercial or residential installations. It also provides the warranty of having the ideal match between the SPD and its associated protection, for maximum safety.

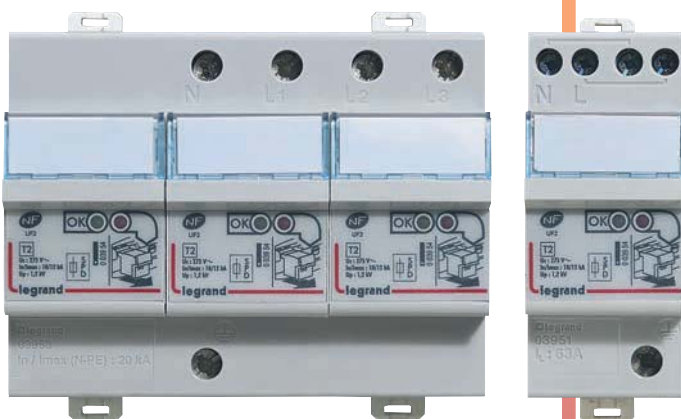

Optimum protection and adaptability to suit local habits

The new Legrand 1P+N and 3P+N SPDs ensure optimum protection for electronic equipment, while providing a universal solution suited to the installation practices of all markets. Available with all levels of discharge current.

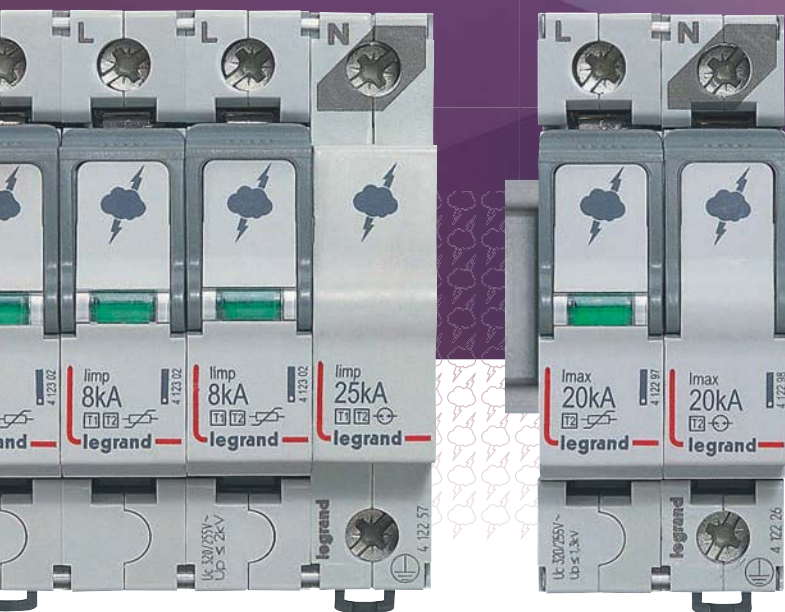

OPTIMUM PROTECTION

The 1P+N and 3P+N SPDs with dedicated protection of the neutral pole discharge the common and differential mode overvoltages that may occur in installations with TT and TNS systems, when there is a lightning strike.

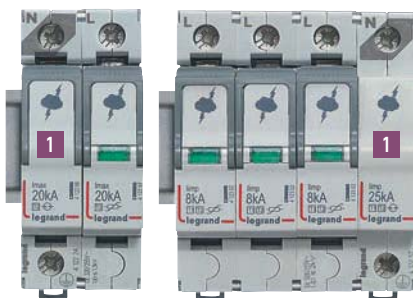

1 Dedicated protection of the neutral

ADAPTABILITY

To adapt to the installation practices of different countries, the 1P+N and 3P+N SPDs are available with the neutral on the right or on the left side.



Neutral on the right Neutral on the left

SPDS... NOT JUST PROTECTION AGAINST THE EFFECTS OF LIGHTNING

The operation of distribution networks, installations and equipment can cause very harmful transient overvoltages. As well as providing protection against the effects of lightning, installing SPDs also protects sensitive equipment against this type of disturbance.

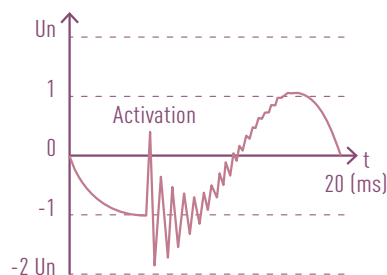

Typical switching overvoltage

Add-on SPDs, increased reliability and safety



Exclusive to Legrand, the add-on SPDs make installation and maintenance simpler and safer and enable the associated circuit breaker to be chosen according to the back-up or discrimination requirements of the installation.

SAVE INSTALLATION TIME

The add-on SPD and its protective circuit breaker are joined together without any wiring, guaranteeing speed of installation and safety.

SIMPLER MAINTENANCE AND INCREASED SAFETY

- The circuit breaker + add-on SPD assembly is joined together by a locking system.
- A single auxiliary to ascertain the status of the SPD (operational or plug-in modules out of service) and its associated circuit breaker.
- It is not possible to reset the circuit breaker if a plug-in module is missing or out of service.
- If a plug-in module is out of service, the circuit breaker remains ON and the SPD can still protect the other poles.

MORE FLEXIBILITY DUE TO THE CHOICE OF CIRCUIT BREAKERS

The add-on SPD can be used with all DX³ 1 module per pole circuit breakers, thus enabling users to choose the characteristics of the protective device, which is not possible with SPDs with integrated protection.

INCREASED RELIABILITY AND MORE EFFECTIVE PROTECTION

With no intermediate wiring between the SPD and the circuit breaker, it is easier to create the shortest possible connection between the supply terminal block and the main terminal block for protective conductors, which provides more effective protection of the equipment

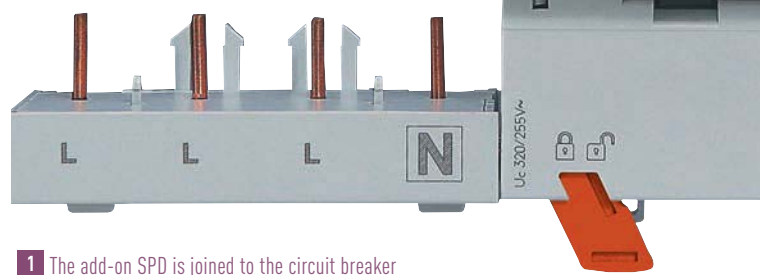
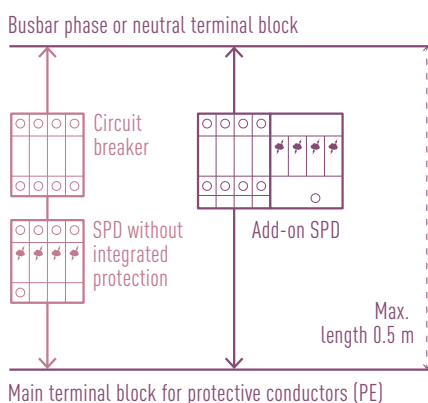

1 The add-on SPD is joined to the circuit breaker simply by driving in these two locking devices.

Design and functionality, perfect integration in distribution boards

Clear, easily identifiable marking for easier maintenance, design in line with other Legrand modular equipment, well thought features: the new SPDs integrate perfectly in the modular rows of Legrand distribution boards.

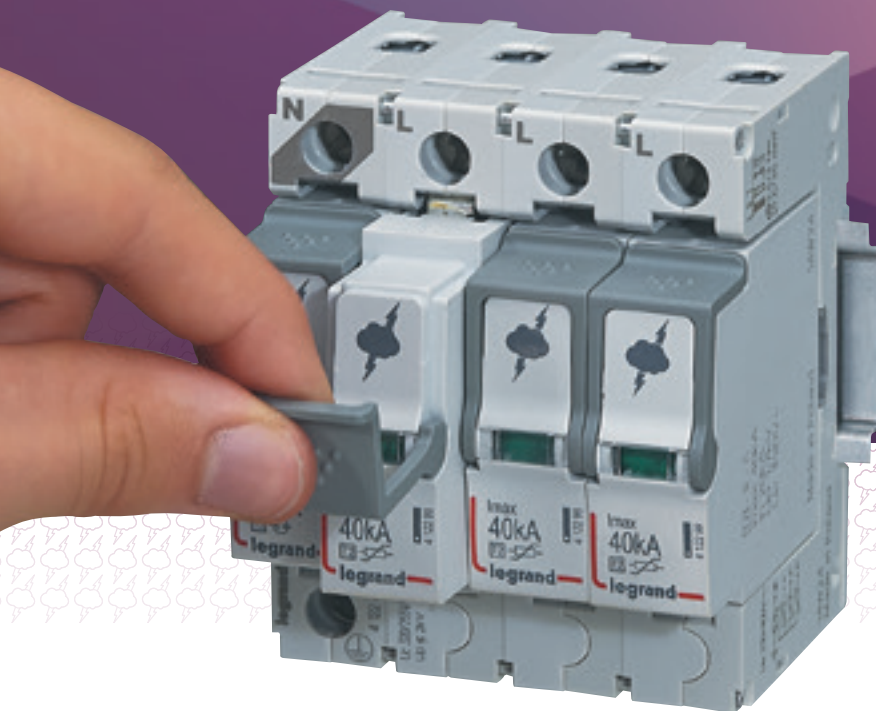

Easier to handle: the plug-in modules are easy to replace thanks to the extraction handles.

STATUS INDICATOR AND REMOTE MONITORING OF INFORMATION

A plug-in module status indicator indicates whether the SPD is operational (green) or out of service (orange). The fault signal contact integrated in all add-on SPDs and available for all protection levels of conventional SPDs provides remote monitoring of this information. The fault signal contact on the add-on SPDs also indicates the status of the circuit breaker (ON/OFF).



- 1 Fault signal contact
- 2 Status indicator

DESIGN AND MARKING

New design in line with the DX³ range of circuit breakers, but with dedicated marking for easy identification of the product once installed in the distribution board.

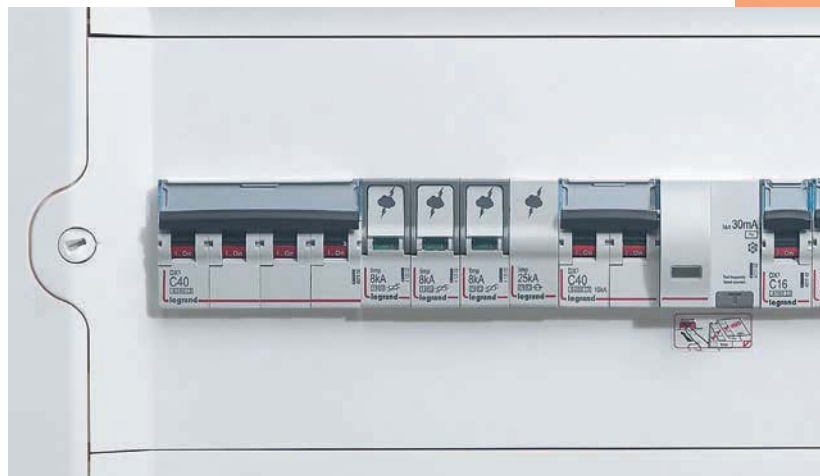

- 3 Dedicated marking for easier identification and maintenance of the SPDs.



Selecting Surge Protective Devices (SPDs) and their associated protection

SPDs are compulsory¹:

- In all areas (apart from specific cases):
 - With lightning protection of buildings (LPS): SPDs in the main distribution boards and distribution boards
 - With IEC/EN 62305 standards
 - Commercial installations
 - Public services, hospitals
- In AQ2 areas with overhead (or partially overhead) lines

Group or individual houses, small commercial buildings

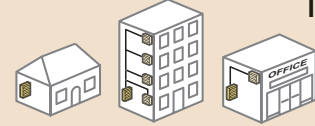

In ≤ 125 A

Low voltage installation	Main distribution board	Power network	Isc	SPD type	SPD (N left/right) + recommended overcurrent protection ⁽²⁾			
	Very high risk All areas	1P+N	≤ 10 kA	 T1+T2 / 12.5 kA	4 122 74/76 + 4 078 06			
		3P			4 122 72 + 4 078 65			
		3P+N			4 122 75/77 + 4 079 34			
		High risk Non-urban areas, mountains, etc.			1P+N	 T1+T2 / 8 kA	4 122 54/56 + 4 078 04	
					3P		4 122 52 + 4 078 63	
					3P+N		4 122 55/57 + 4 079 32	
	Low risk Urban areas, excluding mountains, etc.	1P+N	 T2 / 40 kA	4 122 44/46 + 4 078 02				
		3P		4 122 42 + 4 078 61				
		3P+N		4 122 45/47 + 4 079 30				
	Distribution board All risks	1P+N	≤ 6 kA	 T2 / 12 kA	0 039 51 (integrated protection)			
		3P			-			
		3P+N			0 039 53 (integrated protection)			
1P+N		4 122 24/26 + 4 078 01						
3P		-						
3P+N		 T2 / 20 kA 4 122 25/27 + 4 079 29						
Proximity protection of sensitive equipment			Multi-outlet extensions	6 946 14/48/51/56/64/66/70/71				
			Mosaic	0 775 40				

MB: Main Distribution Board
DB: Distribution Board

Communication lines

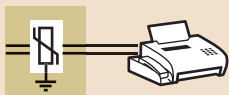







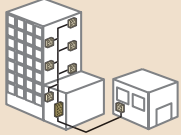
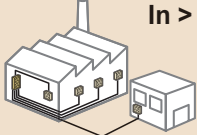

(See p. 14)

1: According to installation standards IEC/HD 60364 parts 443 and 534
 2: Recommended protective device to be used according to the type of SPD and requirements of the installation (see opposite table and technical pages)
 3: Standard modular SPD

SPDs Cat.Nos	T1 / 25 kA and 35 kA 4 122 80/81/82/83		T1+T2 / 12.5 kA 4 122 70/71/72/73/74/75/76/77			T1+T2 / 8 kA 4 122 50/51/52/53/54/55/56/57			T2 / 40 kA 4 122 30/32/33/40/41/42/43/44/45/46/47/64/65/66/67		
	3P	3P+N	1P+N	3P	3P+N	1P+N	3P	3P+N	1P+N	3P	3P+N
Circuit breaker	DPX ³ 160 - 80 A		DX ³ 63 A C curve			DX ³ 40 A C curve			DX ³ 25 A C curve		
	3P	4P	2P	3P	4P	2P	3P	4P	2P	3P	4P
Isc ≤ 10 kA	-	-	4 078 06	4 078 65	4 079 34	4 078 04	4 078 63	4 079 32	4 078 02	4 078 61	4 079 30
Isc ≤ 16 kA	4 200 04	4 200 14	4 092 08	4 092 60	4 093 42	4 092 06	4 092 58	4 093 40	4 092 04	4 092 56	4 093 38
Isc ≤ 25 kA	4 200 44	4 200 54	4 097 74	4 097 87	4 098 00	4 097 72	4 097 85	4 097 98	4 097 70	4 097 83	4 097 96
Isc ≤ 50 kA	4 201 24	4 201 34	4 101 54	4 101 67	4 101 80	4 101 52	4 101 65	4 101 78	4 101 50	4 101 63	4 101 76

Risk levels:

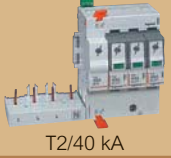
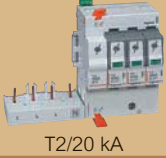

- **Very high risk:** EN/IEC 62305 standards, installations with a LPS or metal structure (acting as a lightning conductor), installations that are isolated, or on a high mountain, or have a history of lightning strikes, etc.
- **High risk:** installations outside of urban areas, in mountainous areas, isolated, at the end of a line, near a body of water, trees or near installations equipped with lightning conductors, etc.
- **Low risk:** installations in urban areas (or grouped buildings), flat areas, or low and medium height mountains

Commercial buildings  $I_n \leq 400 \text{ A}$			Large commercial/ Industrial buildings (IT earthing system: see below)  $I_n > 400 \text{ A}$		
isc	SPD type	SPD (N left/right) + recommended overcurrent protection ⁽²⁾	isc	SPD type	SPD (N left/right) + recommended overcurrent protection ⁽²⁾
$\leq 25 \text{ kA}$	 T1 / 25 kA	-	$\leq 50 \text{ kA}$	 T1/25 kA	-
		4 122 82 + 4 200 44			4 122 82 + 4 201 24
		4 122 83 + 4 200 54			4 122 83 + 4 201 34
	 T1+T2 / 12.5 kA	-		 T1/25 kA	-
		4 122 72 + 4 097 87			4 122 82 + 4 201 24
		4 122 75/77 + 4 098 00			4 122 83 + 4 201 34
 T1+T2 / 12.5 kA	-	 T1+T2/12.5 kA	-		
	4 122 72 + 4 097 87		4 122 72 + 4 101 67		
	4 122 75/77 + 4 098 00		4 122 75/77 + 4 101 80		
$\leq 10 \text{ kA}$	 T2 / 12 kA	0 039 71 (integrated protection)	$\leq 25 \text{ kA}$	 T2/40 kA	-
		-			-
		0 039 73 (integrated protection)			-
$\leq 16 \text{ kA}$	 T2/20 kA	4 122 60/62 + 4 092 03		4 122 64/66 + 4 097 70	
		4 122 42 ⁽³⁾ + 4 092 55		4 122 42 ⁽³⁾ + 4 097 83	
		4 122 61/63 + 4 093 37		4 122 65/67 + 4 097 96	
Mosaic		0 775 40	Mosaic		0 775 40

When low voltage SPDs are present,
protection of all lines entering the building is recommended

T2 / 20 kA			
4 122 20/21/23/24/25/26/27/60/61/62/63			
1P+N	3P	3P+N	
DX ³ 20 A C curve			
2P	3P	4P	
4 078 01	4 078 60	4 079 29	
4 092 03	4 092 55	4 093 37	
4 097 69	4 097 82	4 097 95	
-	-	-	

IT earthing system (all risks)

	SPD type	Network	Icc	SPD + protective device ⁽²⁾
	T1 50 kA/440 V	3P	50 kA	0 030 00 (x 3) + 4 201 24
		3P+N		0 030 00 (x 4) + 4 201 34
	T2 40 kA/440 V	1P+N	25 kA	4 122 30 (x 2) + 4 097 70
		3P		4 122 32 + 4 097 83
		3P+N		4 122 33 + 4 097 96

Class I (T1) low voltage SPDs



4 122 75



4 122 57



4 122 83



4 123 03



4 122 84

Technical characteristics p. 15-17

Protection against transient overvoltages for 230/400 V \sim power networks (50/60 Hz). SPDs compliant with EN/IEC 61643-11 standards
 Recommended for main distribution boards
 Class I+II (T1+T2) : SPDs tested and specified according to both T1 and T2 test classes

Pack	Cat.Nos	SPDs for general protection of main distribution board				
		SPDs with plug-in modules and status indicators: - Green: SPD operational - Orange: plug-in modules to be replaced Earthing systems: TT, TNC, TNS T1+T2 - limp 12,5 kA/pole For general protection of big installations and protection of small installations with external lightning protection (LPS). Up: 1.5 kV - I _{max} : 60 kA/pole - U _c : 320 V \sim Recommended MCB: DX ³ 63 A - C curve				
		Number of poles	Neutral position	I _{total} (10/350)	Remote status monitoring (FS contact)	Number of modules
1	4 122 70	1P	-	12.5 kA	No	1
1	4 122 74 ¹	1P+N	Left	25 kA	Yes	2
1	4 122 76 ¹	1P+N	Right	25 kA	Yes	2
1	4 122 71	2P	-	25 kA	No	2
1	4 122 72	3P	-	37.5 kA	Yes	3
1	4 122 75 ¹	3P+N	Left	50 kA	Yes	4
1	4 122 77 ¹	3P+N	Right	50 kA	Yes	4
1	4 122 73	4P	-	50 kA	No	4
		T1+T2 - limp 8 kA/pole SPDs for small installations without external lightning protection (LPS) Up: 1.3 kV - I _{max} : 50 kA/pole - U _c : 320 V \sim Recommended MCB: DX ³ 40 A - C curve				
1	4 122 50	1P	-	8 kA	No	1
1	4 122 54 ¹	1P+N	Left	16 kA	No	2
1	4 122 56 ¹	1P+N	Right	16 kA	No	2
1	4 122 51	2P	-	16 kA	No	2
1	4 122 52	3P	-	25 kA	No	3
1	4 122 55 ¹	3P+N	Left	25 kA	No	4
1	4 122 57 ¹	3P+N	Right	25 kA	No	4
1	4 122 53	4P	-	32 kA	No	4

Pack	Cat.Nos	SPDs for high risk level installations				
		SPDs for big installations with external lightning protection (LPS) and for high risk level installations according to EN/IEC 62305 standards. T1 - limp 50 kA/pole - 440V\sim (IT) - Monobloc Up: 2.5 kV - U _c : 440 V \sim Earthing systems: TT, TNC, TNS, IT Recommended MCCB: DPX ³ 160 - 80 A				
		Number of poles	I _{total} (10/350)	Remote status monitoring (FS contact)	Number of modules	
1	0 030 00 ²	1P	50 kA	No	2	

Pack	Cat.Nos	SPDs for high risk level installations (continued)				
		T1 - limp 35 kA/pole - 440V\sim (IT) - Plug-in SPDs with plug-in modules and status indicators: - Green: SPD operational - Red: plug-in modules to be replaced Up: 2.5 kV - U _c : 440 V \sim Earthing systems: TT, TNC, TNS, IT Recommended MCCB: DPX ³ 160 - 80 A				
		Number of poles	Neutral position	I _{total} (10/350)	Remote status monitoring (FS contact)	Number of modules
1	4 122 80	1P	-	35 kA	Yes	2
		T1 - limp 25 kA/pole SPDs with plug-in modules and status indicators: - Green: SPD operational - Red: plug-in modules to be replaced Up: 1.5 kV - U _c : 350 V \sim Earthing systems: TT, TNC, TNS. Recommended MCCB: DPX ³ 160 - 80 A				
1	4 122 81 ¹	1P+N	Right	50 kA	Yes	4
1	4 122 82	3P	-	75 kA	Yes	6
1	4 122 83 ¹	3P+N	Right	100 kA	Yes	8
		Replacement plug-in modules				
1	4 123 02	For SPDs T1+T2 - 8 kA Cat.Nos 4 122 50/51/52/53/54/55/56/57				
1	4 123 03	For SPDs T1+T2 - 12.5 kA Cat.Nos 4 122 70/71/72/73/74/75/76/77				
1	4 122 84	For SPDs T1 - 25 kA Cat.Nos 4 122 81/82/83 and 0 030 20/22/23/27				
1	4 122 85	N-PE module for SPDs T1 - 25 kA Cat.Nos 4 122 81/83 and 0 030 23				
1	4 122 86	For SPDs T1 - 35 kA Cat.No 4 122 80				

Pack	Cat.Nos	Cabling accessories				
1	4 123 10	Ready to use cabling kit consisting of 5 conductors (including the earth conductor) Cross section :16mm ² Length : 40cm For cabling SPDs in industrial enclosures (for EN/IEC 61439 compliance).				
1: 1P+N and 3P+N: L-N and N-PE protection modes (common and differential modes), the N pole being protected by encapsulated spark gaps. Also called sometimes 1+1 and 3+1 2: Replaced mid 2015 by Cat.No 4 122 80						

Class II (T2) low voltage SPDs

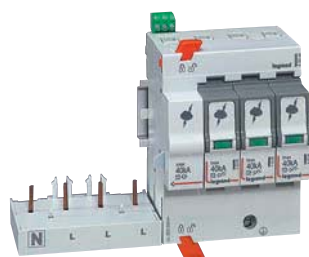

4 122 65

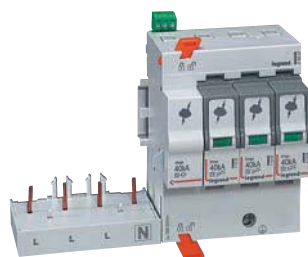

4 122 67



4 122 45



4 122 99

Technical characteristics p. 15-17

Protection against transient overvoltages for 230/400 V \sim power networks (50/60 Hz). SPDs compliant with EN/IEC 61643-11 standards
Recommended for distribution boards

Pack	Cat.Nos	T2 add-on SPDs																																				
		SPDs with plug-in modules and status indicators: - Green: SPD operational - Orange: plug-in modules to be replaced SPDs providing increased safety during their lifetime and maintenance cycles. Prewired MCB connexions for increased reliability and for quick and easy Installation. To be equipped with DX ³ MCBs (1 module/pole) Earthing systems: TT, TNS																																				
		T2 - I_{max} 40 kA/pole SPDs recommended for power installations Up: 1.7 kV - In: 20 kA/pole - Uc: 320 V \sim Recommended MCB: DX ³ 25 A - C curve																																				
		<table border="1"> <thead> <tr> <th>Number of poles</th> <th>Neutral position</th> <th>Remote status monitoring (FS contact)</th> <th>Number of modules</th> </tr> </thead> <tbody> <tr> <td>1P+N</td> <td>Left</td> <td>Yes</td> <td>4</td> </tr> <tr> <td>1P+N</td> <td>Right</td> <td>Yes</td> <td>4</td> </tr> <tr> <td>3P+N</td> <td>Left</td> <td>Yes</td> <td>8</td> </tr> <tr> <td>3P+N</td> <td>Right</td> <td>Yes</td> <td>8</td> </tr> </tbody> </table>	Number of poles	Neutral position	Remote status monitoring (FS contact)	Number of modules	1P+N	Left	Yes	4	1P+N	Right	Yes	4	3P+N	Left	Yes	8	3P+N	Right	Yes	8																
Number of poles	Neutral position	Remote status monitoring (FS contact)	Number of modules																																			
1P+N	Left	Yes	4																																			
1P+N	Right	Yes	4																																			
3P+N	Left	Yes	8																																			
3P+N	Right	Yes	8																																			
1	4 122 64 ¹	1P+N Left Yes 4																																				
1	4 122 66 ¹	1P+N Right Yes 4																																				
1	4 122 65 ¹	3P+N Left Yes 8																																				
1	4 122 67 ¹	3P+N Right Yes 8																																				
		T2 - I_{max} 20 kA/pole SPDs recommended for small installations Up: 1.2 kV - In: 5 kA/pole - Uc: 320 V \sim Recommended MCB: DX ³ 20 A - C curve																																				
1	4 122 60 ¹	1P+N Left Yes 4																																				
1	4 122 62 ¹	1P+N Right Yes 4																																				
1	4 122 61 ¹	3P+N Left Yes 8																																				
1	4 122 63 ¹	3P+N Right Yes 8																																				
Pack	Cat.Nos	T2 SPDs																																				
		SPDs with plug-in modules and status indicators: - Green: SPD operational - Orange: plug-in modules to be replaced																																				
		T2 - I_{max} 40 kA/pole SPDs recommended for power installations Up: 1.7 kV - In: 20 kA/pole - Uc: 320 V \sim Earthing systems : TT, TNC, TNS Recommended MCB: DX ³ 25 A - C curve																																				
		<table border="1"> <thead> <tr> <th>Number of poles</th> <th>Neutral position</th> <th>Remote status monitoring (FS contact)</th> <th>Number of modules</th> </tr> </thead> <tbody> <tr> <td>1P</td> <td>-</td> <td>No</td> <td>1</td> </tr> <tr> <td>1P+N</td> <td>Left</td> <td>No</td> <td>2</td> </tr> <tr> <td>1P+N</td> <td>Right</td> <td>No</td> <td>2</td> </tr> <tr> <td>2P</td> <td>-</td> <td>No</td> <td>2</td> </tr> <tr> <td>3P</td> <td>-</td> <td>Yes</td> <td>3</td> </tr> <tr> <td>3P+N</td> <td>Left</td> <td>No</td> <td>4</td> </tr> <tr> <td>3P+N</td> <td>Right</td> <td>No</td> <td>4</td> </tr> <tr> <td>4P</td> <td>-</td> <td>No</td> <td>4</td> </tr> </tbody> </table>	Number of poles	Neutral position	Remote status monitoring (FS contact)	Number of modules	1P	-	No	1	1P+N	Left	No	2	1P+N	Right	No	2	2P	-	No	2	3P	-	Yes	3	3P+N	Left	No	4	3P+N	Right	No	4	4P	-	No	4
Number of poles	Neutral position	Remote status monitoring (FS contact)	Number of modules																																			
1P	-	No	1																																			
1P+N	Left	No	2																																			
1P+N	Right	No	2																																			
2P	-	No	2																																			
3P	-	Yes	3																																			
3P+N	Left	No	4																																			
3P+N	Right	No	4																																			
4P	-	No	4																																			
1	4 122 40	1P - No 1																																				
1	4 122 44 ¹	1P+N Left No 2																																				
1	4 122 46 ¹	1P+N Right No 2																																				
1	4 122 41	2P - No 2																																				
1	4 122 42	3P - Yes 3																																				
1	4 122 45 ¹	3P+N Left No 4																																				
1	4 122 47 ¹	3P+N Right No 4																																				
1	4 122 43	4P - No 4																																				
		T2 - I_{max} 40 kA/pole - 440V\sim (IT) SPDs recommended for big installations Up: 2.1 kV - In: 20 kA/pole - Uc: 440 V \sim Earthing systems : TT, TNC, TNS, IT Recommended MCB: DX ³ 25 A - C curve																																				
1	4 122 30	1P - No 1																																				
1	4 122 32	3P - Yes 3																																				
1	4 122 33	4P - Yes 4																																				
		T2 - I_{max} 20 kA/pole SPDs recommended for small installations Up: 1.2 kV - In: 5 kA/pole - Uc: 320 V \sim Earthing systems : TT, TNC, TNS Recommended MCB: DX ³ 20 A - C curve																																				
1	4 122 20	1P - No 1																																				
1	4 122 24 ¹	1P+N Left No 2																																				
1	4 122 26 ¹	1P+N Right No 2																																				
1	4 122 21	2P - No 2																																				
1	4 122 25 ¹	3P+N Left No 4																																				
1	4 122 27 ¹	3P+N Right No 4																																				
1	4 122 23	4P - No 4																																				
		Replacement plug-in modules																																				
1	4 122 99	For SPDs T2 - 40 kA Cat.Nos 4 122 40/41/42/43/44/45/ 46/47/64/65/66/67																																				
1	4 123 00	N-PE module for SPDs T2 - 40 kA Cat.Nos 4 122 44/45/46/47																																				
1	4 123 01	For SPDs T2 - 440 V Cat.Nos 4 122 30/32/33																																				
1	4 122 97	For SPDs T2 - 20 kA Cat.Nos 4 122 20/21/23/24/25/26/27/60/61/62/63																																				
1	4 123 98	N-PE module for SPDs T2 - 20 kA Cat.Nos 4 122 24/25/26/27																																				

1: 1P+N and 3P+N: L-N and N-PE protection modes (common and differential modes), the N pole being protected by encapsulated spark gaps. Also called sometimes 1+1 and 3+1

Class II (T2) low voltage SPDs with integrated protection



SPDs for telephone lines



Technical characteristics p. 15-17

SPDs with integrated protection against overload currents and short-circuit currents
SPDs compliant with EN/IEC 61643-11 standards
For 230/400 V~ power networks (50/60 Hz)

Pack	Cat.Nos	Protection for consumer units
		For residential and small commercial installations With plug-in modules and status indicators: - Green: SPD operational - Red: plug-in module need to be replaced T2 self protected SPDs - I_{max} 12 kA/pole For installations with low risk level (in urban areas, underground power supplies, etc.) In: 10 kA/pole - U _c : 275 V~ Earthing systems: TT, TNS Cat. No. 0 039 51: SPDs with Y connection (both incoming and outgoing terminals at the top of the SPDs) providing better protection against overvoltages
1	0 039 51 ¹	Number of poles: 1P+N Neutral position: Left Integrated protection: I _{sc} ≤ 6 kA Number of modules: 2
1	0 039 53 ¹	Number of poles: 3P+N Neutral position: Left Integrated protection: I _{sc} ≤ 6 kA Number of modules: 6

Pack	Cat.Nos	Protection for secondary distribution boards
		Protection of sensitive equipment. With plug-in modules and status indicators: - Green: SPD operational - Red: plug-in module need to be replaced In: 10 kA/pole - U _c : 275 V~ Earthing systems: TT, TNS. Cat. No. 0 039 71: both incoming and outgoing terminals at the top of the SPDs, providing better protection against overvoltages T2 self protected SPDs - I_{max} 12 kA/pole
1	0 039 71 ¹	Number of poles: 1P+N Neutral position: Left Integrated protection: I _{sc} ≤ 10 kA Number of modules: 2
1	0 039 73 ¹	Number of poles: 3P+N Neutral position: Left Integrated protection: I _{sc} ≤ 10 kA Number of modules: 6

Replacement plug-in modules

For self protected SPDs

1 0 039 54 Cat.Nos 0 039 51/53
1 0 039 74 Cat.Nos 0 039 71/73

For old SPDs

1 0 039 28 Cat.Nos 0 039 20/21/22/23
1 0 039 34 Cat.Nos 0 039 30/31/32/33
1 0 039 39 Cat.Nos 0 039 35/36/38
1 0 039 44 Cat.Nos 0 039 40/41/43

1: 1P+N and 3P+N: L-N and N-PE protection modes (common and differential modes), the N pole being protected by encapsulated spark gaps. Also sometimes called 1+1 and 3+1.

Technical characteristics p. 15-17

Pack	Cat.Nos	SPDs for telephone and data lines
		Overvoltage protection of equipment such as telephones, modems, video door entry phones, RS485 networks, measurement loops, etc. Not compatible with VDSLs SPDs needed to provide complete protection of the installation when low voltage SPDs are present (TS/IEC 61643-12). SPDs with status indicators: - Green: SPD operational - Orange: plug-in module need to be replaced Compliant with EN/IEC 61643-21 standards "Analogue" SPD (STN, non-unbundled ADSL, etc.)
1	0 038 28	In/I _{max} : 5/10 kA Max. voltage(U _c): 170 V Level of protection (Up): 260 V No. of modules: 1
1	0 038 29	"Digital" SPD (unbundled ADSL, SDSL, ISDN, etc.) 5/10 kA 48 V 100 V 1

Surge Protective Devices (SPDs)

protection against transient overvoltages

Protection against lightning and overvoltages

Protection against the effects of lightning is essentially based on:

- Protecting buildings using a lightning protection system (LPS or lightning conductors) to catch lightning strikes and to drive the lightning current to earth.
- The use of surge protective devices (SPDs) to protect equipment.
- The design of the earthing system (passive protection of the installation).

Throughout the world, there are millions of lightning strikes each day in the summer (up to 1000 lightning strikes/second). Lightning is responsible for 25% to 40% of all damage to equipment. When added to industrial overvoltages (switching overvoltages due to the operation of internal equipment), they account for more than 60% of all electrical damages, which can be prevented by installing SPDs (according to the country and type of installation - source: insurance companies).

In some countries, and depending on the end use of the building, national regulations may always stipulate the installation of SPDs (for example, Germany, Austria, Norway, etc.). If there are no specific national regulations, SPDs are usually specified by national installation standards (based on HD/IEC 60364 international installation standards) and EN/IEC 62305 standards.

External lightning protection system (LPS) or lightning conductors: protection of buildings (EN/IEC 62305)

An external lightning protection system (LPS) protects buildings against direct lightning strikes. It is generally based on the use of lightning conductors (single rod, with sparkover device, meshed cage, etc.) and/or the metallic structure of the building.

If there is an LPS or if a lightning risk assessment has been carried out in accordance with EN/IEC 62305 standards, SPDs are generally required in the main distribution board (T1 SPDs) and distribution boards (T2 SPDs).

Determination of the SPDs in the main distribution board in accordance with EN/IEC 62305 and TS/IEC 61643-12 (if there is insufficient information available):

LPL: Lightning protection level	Total lightning current of the LPS	Min. value of Imp current of the SPD (T1)	Usage practices
I	200 kA	25 kA/pole (IT: 35kA min.)	Power installations
II	150 kA	18.5 kA/pole	Rarely used
III/IV	100 kA	12.5 kA/pole	Small installations

1: LPL (Lightning Protection Level)

Surge protective device (SPD) (internal protection)

The SPD

- Protects sensitive devices against overvoltages caused by lightning and industrial overvoltages, by limiting the overvoltages to values that are tolerated by the equipment
- Limits the possible harmful consequences in terms of the safety of people (medical equipment installed in the home, security systems, environmental systems, etc.)
- Maximises the continuity of operation of equipment and limits production losses

SPDs and standards

Standards EN/IEC 61643-11

Type of SPD		Test waves
EN 61643-11	IEC 61643-11	
Type 1 (T1)	Class I (T1)	Imp: 10/350 μ s (discharge current) In: 8/20 μ s (nominal current, 15 shocks)
Type 2 (T2)	Class II (T2)	Imax: 8/20 μ s (discharge current) In: 8/20 μ s (nominal current, 15 shocks)

T1+T2 SPDs: tested in accordance with both methods.

T1 or T1+T2 SPDs are being increasingly used at the supply origin of installations, even when there is no lightning conductor, as they enable higher energies to be discharged and increase the service life the SPD.

HD/IEC 60364 electrical installation standards

According to articles 443 and 534 of HD/IEC 60364 standards and the TS/IEC 61643-12 guides, the use of SPDs in new or renovated buildings is compulsory at the supply origin of the installation in the following cases:

- Buildings with lightning conductors (T1 SPDs, $I_{imp} \geq 12.5$ kA)
- Buildings with totally or partially overhead power supplies in AQ2 geographical areas (article 443.3.2.1 - AQ2: $N_k > 25$, see map below) and based on a risk assessment taking into account the type of power supply to the building (article 443.3.2.2)

According to article 443.3.2.2, SPDs (Type 2) are also required in the following cases:

- Commercial/industrial buildings, public buildings and services, religious buildings, schools and large residential complexes, etc.
- Hospitals and buildings containing medical equipment and/or security systems for people and property (fire alarm, technical alarms, etc.)

Important: it is advisable to install an SPD when the safety of people may depend on the continuity of service of equipment (even if this is not required by national standards). Although not compulsory according to the installation standards, an SPD should always be installed to protect the communication equipment when there is an SPD on the low voltage power network.

These rules should change in 2015. Please consult Legrand.

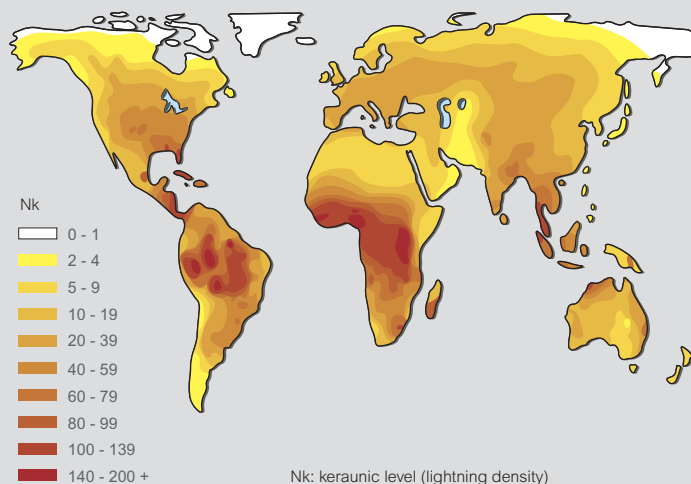

Protection of distribution boards and sensitive equipment (cascaded protection)

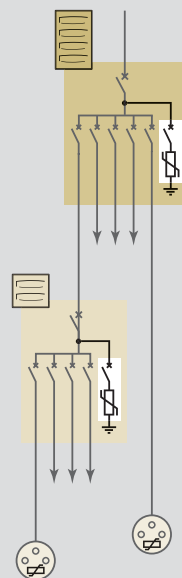

Effective protection against overvoltages cannot generally be assured with a single SPD if its protection level (U_p) is greater than 1.2 kV (EN/IEC 62305 and TS/IEC 61643-12).

When there are overvoltages, an SPD protects equipment by limiting these overvoltages to values that can be tolerated by the equipment. Thus, depending on its discharge capacity (discharge current I_n , I_{max} , etc.) and its protection level (U_p), an SPD will limit these overvoltages to varying values depending on the energy levels involved. The overvoltage values that may be transmitted downstream of the SPD may double over distances of more than 10 m due to resonances associated with the type of electrical installation and the type of equipment. Overvoltages greater than 2.5 kV may then occur and damage equipment if the residual energy is high enough (2.5 kV being the insulation level of most electrical and electronic equipment, or typically 1.5 kV for electrical domestic appliances).

SPDs should be installed in the distribution boards supplying equipment that is sensitive or critical for the activity being carried out (and/or near to equipment with proximity SPDs).

Surge Protective Devices (SPDs)

technical characteristics

Modular SPDs

230/400 V~ power network (50/60 Hz) - Degree of protection IP 20

Operating temperature: -10 to +40°C/Storage temperature: -20 to +70°C

1P+N (3P+N) SPDs: L-N and N-PE protection, also called 1+1 (3+1 resp.) or CT2 type protection depending on installation standards.

Cat.Nos	Type	Poles	Earthing system	Max. voltage (Uc)	Protection mode	Nominal current In/pole (8/20)	Max. discharge current			Protection level		Max. short-circuit current Isc (Isc cr)	Protective device to be used ¹	FS auxiliary (remote status monitoring)		
							I _{max} /pole (8/20)	I _{imp} /pole (10/350)	I _{total} (10/350)	Up (L-N/L-PE/N-PE)	Up at 5 kA					
0 030 00 4 122 80	T1/50 kA T1/35 kA	1P	TT, TNC, TNS, IT	440 V~	CT1	50 kA 35 kA		50 kA 35 kA	50 kA 35 kA	2.5 kV		50 kA	DPX ³ 160 80 A	no yes		
4 122 81	T1/25 kA	1P+N	TT, TNS	350 V~	CT2	25/50 kA		25/50 kA	50 kA	1.5/2.5/1.5 kV				yes		
4 122 82	T1/25 kA	3P	TNC	350 V~	CT1	25 kA		25 kA	75 kA	1.5 kV				yes		
4 122 83	T1/25 kA	3P+N	TT, TNS	350 V~	CT2	25/100 kA		25/100 kA	100 kA	1.5/2.5/1.5 kV				yes		
4 122 70	T1+T2/12.5 kA	1P	TT, TNC, TNS	320 V~	CT1	25 kA	60 kA	12.5 kA	12.5 kA	1.5 kV at 12.5 kA 1.9 kV at 25 kA	1 kV	50 kA	DX ³ 63 A C curve	no		
4 122 71	T1+T2/12.5 kA	2P	TT, TNS	320 V~	CT1	25 kA	60 kA	12.5 kA	25 kA					no		
4 122 72	T1+T2/12.5 kA	3P	TNC	320 V~	CT1	25 kA	60 kA	12.5 kA	37.5 kA					yes		
4 122 73	T1+T2/12.5 kA	4P	TT, TNS	320 V~	CT1	25 kA	60 kA	12.5 kA	50 kA					no		
4 122 74/76	T1+T2/12.5 kA	1P+N	TT, TNS	320 V~	CT2	25/25 kA	60 kA	12.5/25 kA	25 kA	1.5/1.6/1.5 kV at 12.5 kA 1.9/2.1/1.5 kV at 25 kA	1 kV	50 kA	DX ³ 40 A C curve	yes		
4 122 75/77	T1+T2/12.5 kA	3P+N	TT, TNS	320 V~	CT2	25/50 kA	60 kA	12.5/50 kA	50 kA					yes		
4 122 50	T1+T2/8 kA	1P	TT, TNC, TNS	320 V~	CT1	20 kA	50 kA	8 kA	8 kA	1.2 kV at 8 kA 1.7 kV at 20 kA	1 kV			50 kA	DX ³ 40 A C curve	no
4 122 51	T1+T2/8 kA	2P	TT, TNS	320 V~	CT1	20 kA	50 kA	8 kA	16 kA							no
4 122 52	T1+T2/8 kA	3P	TNC	320 V~	CT1	20 kA	50 kA	8 kA	25 kA			no				
4 122 53	T1+T2/8 kA	4P	TT, TNS	320 V~	CT1	20 kA	50 kA	8 kA	32 kA			no				
4 122 54/56	T1+T2/8 kA	1P+N	TT, TNS	320 V~	CT2	20 kA	50 kA	8 kA	16 kA	1.2/1.5/1.5 kV at 8 kA 1.7/2/1.5 kV at 20 kA	1 kV	50 kA	DX ³ 25 A C curve	no		
4 122 55/57	T1+T2/8 kA	3P+N	TT, TNS	320 V~	CT2	20 kA	50 kA	8 kA	25 kA					no		
4 122 40	T2/40 kA	1P	TT, TNC, TNS	320 V~	CT1	20 kA	40 kA			1.5 kV at 15 kA 1.7 kV at 20 kA	1 kV			50 kA	DX ³ 25 A C curve	no
4 122 41	T2/40 kA	2P	TT, TNS	320 V~	CT1	20 kA	40 kA									no
4 122 42	T2/40 kA	3P	TNC	320 V~	CT1	20 kA	40 kA					yes				
4 122 43	T2/40 kA	4P	TT, TNS	320 V~	CT1	20 kA	40 kA					no				
4 122 44/46 4 122 64/66	T2/40 kA	1P+N	TT, TNS	320 V~	CT2	20 kA	40 kA			1.5/1.6/1.4 kV at 15 kA 1.7/2/1.4 kV at 20 kA	1 kV	50 kA	DX ³ 25 A C curve	no yes		
4 122 45/47 4 122 65/67	T2/40 kA	3P+N	TT, TNS	320 V~	CT2	20 kA	40 kA							50 kA 25 kA	no yes	
4 122 30	T2/40 kA	1P	TT, TNC, TNS, IT	440 V~	CT1	20 kA	40 kA			1.8 kV at 15 kA 2.1 kV at 20 kA	1.3 kV			50 kA	DX ³ 25 A C curve	no
4 122 32	T2/40 kA	3P	TNC, IT	440 V~	CT1	20 kA	40 kA									yes
4 122 33	T2/40 kA	4P	TT, TNS, IT	440 V~	CT1	20 kA	40 kA					yes				
4 122 20	T2/20 kA	1P	TT, TNS	320 V~	CT1	10 kA	20 kA			1.2 kV at 5 kA 1.4 kV at 10 kA	1.2 kV	25 kA	DX ³ 20 A C curve	no		
4 122 21	T2/20 kA	2P	TT, TNS	320 V~	CT1	10 kA	20 kA							no		
4 122 23	T2/20 kA	4P	TT, TNS	320 V~	CT1	10 kA	20 kA							no		
4 122 24/26 4 122 60/62	T2/20 kA	1P+N	TT, TNS	320 V~	CT2	10/20 kA	20 kA			1.2/1.4/1.4 kV at 5 kA 1.4/1.4/1.4 kV at 10 kA	1.2 kV			25 kA	DX ³ 20 A C curve	no yes
4 122 25/27 4 122 61/63	T2/20 kA	3P+N	TT, TNS	320 V~	CT2	10/20 kA	20 kA					no yes				
0 039 51 0 039 71	T2+T3/12 kA	1P+N	TT, TNS	275 V~	CT2	10/10 kA	12 kA			1.1/1.2/1.2 kV at 10 kA	1 kV	6 kA 10 kA	integrated protection			no
0 039 53 0 039 73	T2+T3/12 kA	3P+N	TT, TNS	275 V~	CT2	10/20 kA	20 kA									

CT1: L(N)-PE protection modes.

CT2: L-N and N-PE protection modes.

1: DPX³ (with T1 SPDs), DX³ or similar type circuit breakers (with T2 and T1+T2 SPDs). For fuse protection or values other than those indicated in the table: please consult Legrand.

Characteristics of proximity SPDs

230 V~ protection: Type 3 (T3) SPDs

Cat.Nos	0 775 40	6 946 64/66/70	6 946 14/48/51/56/71
Protection mode	LN/NPE	LN/LPE/NPE	LN
Up	1/1.2 kV	1 kV	1 kV
I _{max}	6 kA	-	-
I _n	1.5 kA	2 kA	2 kA
U _{oc}	3 kV	4 kV	4 kV

TT earthing system: Installation downstream of a residual current device (HPI type recommended).

RJ 45/RJ 11 protection

Cat. No.	6 946 64	6 946 70
U _c	200 V	
U _p	600 V	
I _{max}	1.5 kA	
I _n	1 kA	
U _{oc}	3 kV	

TV protection (9.5 mm coax.)

Cat. No.	6 946 66
U _c	50 V
U _p	900 V
I _{max}	5 kA
I _n	1 kA
U _{oc}	3 kV

Installation

Associated overcurrent protection

SPDs must be protected by a circuit breaker (or fuses), to provide protection in the event of an overload, which may make the SPD reach its end of life (see selection table p. 10-11). This protective device will be defined to be coordinated or discriminating with regard to upstream protective devices.

Connection principles

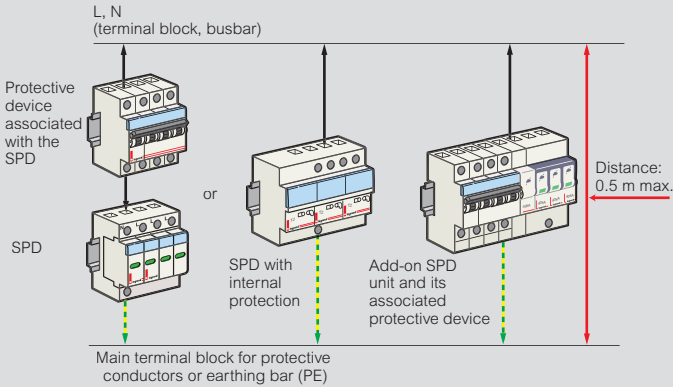

Connection lengths: as short as possible (< 50 cm if possible).

EMC (Electromagnetic Compatibility) rules: avoid loops, fix the cables firmly against the exposed metal conductive parts of the enclosure.

SPD types and earthing systems

When possible (according to local rules), the SPD and its associated overcurrent protection (P2) should be installed upstream of the main protection (P1) as shown below (according to standards HD/IEC 60364).

SPDs and TT earthing system

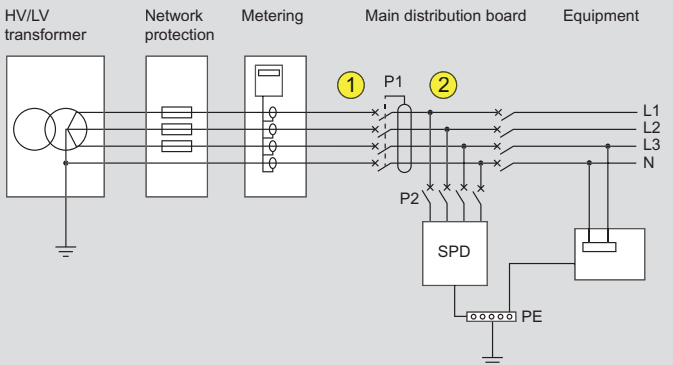

P1: main protection of the installation

SPD: surge protective device with U_c 275 or 320 V recommended

① (upstream of P1): 1P+N/3P+N SPDs only (except for Cat.Nos 0 039 51/53/71/73).

1P/2P/3P/4P SPDs and Cat.Nos 0 039 51/53/71/73 must always be installed downstream of a residual current device (discriminating or delayed, at the supply end of the installation).

② (downstream of P2): any SPD.

SPDs and TN (TNC, TNS and TNC-S) earthing systems

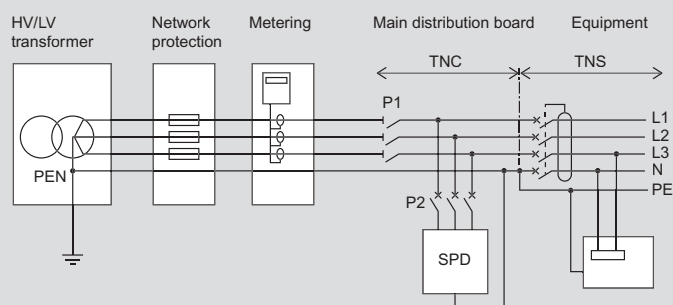

P1: main protection of the installation

SPD: surge protective device with U_c 275 or 320 V recommended

SPDs and IT earthing system

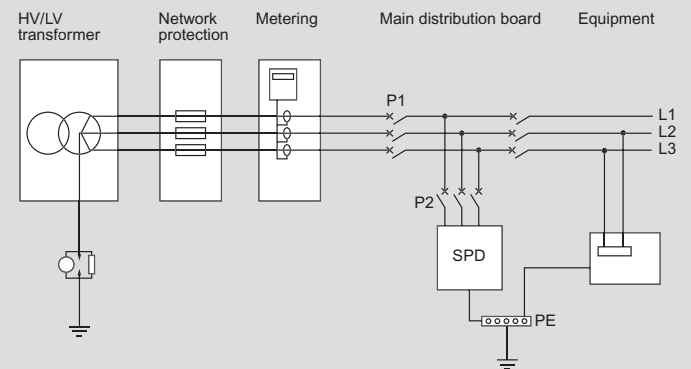

P1: main protection of the installation

SPD: surge protective device with U_c 440 V ($U_c < 440$ V prohibited)

Coordinating upstream/downstream SPDs

Consists of ensuring that any downstream SPD (in distribution enclosures or proximity SPDs) is correctly coordinated in energy terms with any SPD located upstream (TS 61643-12).

Minimum distances between SPDs

Upstream SPD	Downstream SPD	Min. distance (m)
T1/50 and T1/25	T2/40	10
T1/12.5 and T1/8	T2/40	6
	T2/20, T2/12	8
T2/40	T2/20	4
	T2/12	6
T2/20 and T2/12	Proximity SPD	2

If it is not possible to comply with these distances, insert decoupling inductors on each phase and neutral conductor.



FOLLOW US
ALSO ON

@ www.legrand.com

 www.youtube.com/user/legrand

 www.facebook.com/Legrand

 twitter.com/legrand_news

 pinterest.com/legrandgroup



World Headquarters
and International Department
87045 Limoges Cedex - France
Tel. : + 33 (0) 5 55 06 87 87
Fax: + 33 (0) 5 55 06 74 55